

PROCESS BELTS FOR THE WOOD INDUSTRY

FLEXOPLAN™ | CONDUCTO® | SQUARE WEAVE | TELA MICRODUR | LINEAR SCREEN

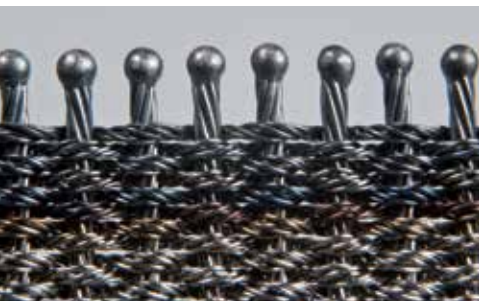



1. OSB for the construction industry 2. FLEXOPLAN 163 Special with welded edges 3. Connection guides: riveted, soldered or made of sheet metal

FLEXOPLAN™ CAUL SCREENS FOR OSB BOARDS WITH GRIP

Highly robust yet flexible: GKD manufactures custom-built FLEXOPLAN 163 Special solutions for its customers as caul screens for producing OSB boards in stationary single and multi-stage presses. The precise marking of our double-twisted screens ensures that the defined surface coarseness is attained. With a riveted or soldered guide or a special sheet metal guide, FLEXOPLAN caul screens excel in all conventional production facilities. These guides are always manufactured in accordance with the plant constructor's requirements. The consistent high quality and reproducibility of the surface is one of the reasons behind the success of FLEXOPLAN caul screens – and not only in North America's construction industry.

| FLEXOPLAN 163 Special (caul screens) | |
|--------------------------------------|-----------------|
| Number | 18.35/4.48 p.cm |
| Warp | 0.19/5x + E |
| Weft | 0.30/7x |
| Material combination | |
| carbon steel, complete | Article No.: |
| Special version in SST available | 42103010 |
| Weave type | plain weave |

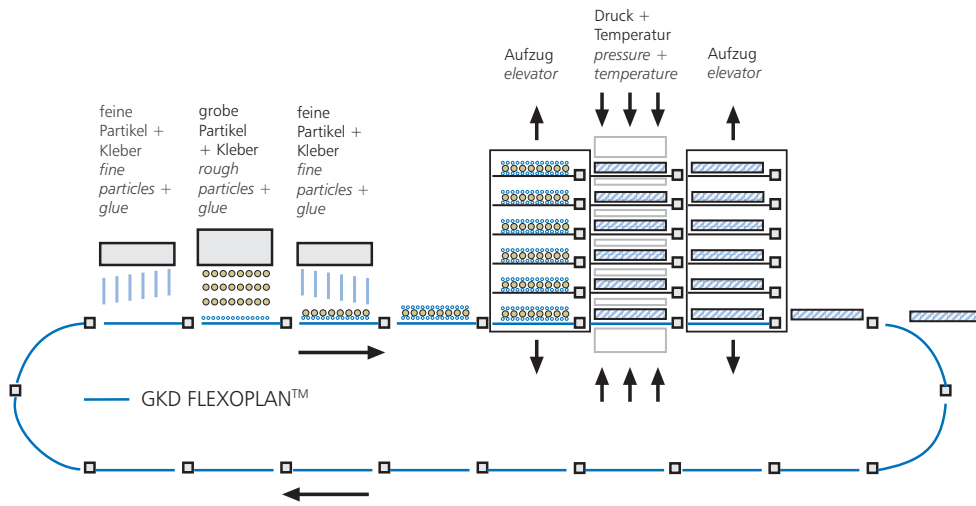

1. Multi-stage press 2. Particle board 3. FLEXOPLAN Type 452 KP

FLEXOPLAN™ CAUL SCREENS FOR PARTICLE, MDF & FINE SURFACES

When used as a caul screen, FLEXOPLAN Type 452 KP is a proven solution for manufacturing chip or MDF boards with smooth surfaces. Moreover, this mesh type made of fine warp wires and flexible weft wires retains its high degree of flexibility even when pressing at high temperatures.

The efficiency and process safety of our FLEXOPLAN Type 452 KP caul screens with twilled weave mesh make them the perfect solution for presses of these and other renowned manufacturers: Becker & van Hüllen, Bison, Dieffenbacher, Metso, Motalla, Rautte, Schenck, Siempelkamp, Sunds and Washington Iron.

| FLEXOPLAN 452 KP (caul screens) | |
|---------------------------------|-------------------|
| Number | 78.76/5.95 p.cm |
| Warp | 0.25 mm |
| Weft | 0.30/7x |
| | |
| Material combination | Article No.: |
| carbon steel, complete | 14164000 |
| SST/carbon steel | 14343410 |
| SST, complete | 14343411 |
| Weave type | twilled weave 2/2 |



— GKD Press-Prägeband / Embossing press belt

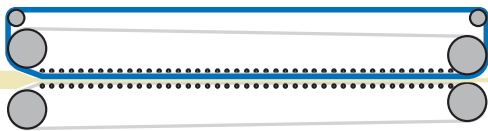

1. Embossed OSB board 2. Diagram of a continuous press 3. Embossing press belt on GKD stretching bench

FLEXOPLAN™ EMBOSSING PRESS BELTS FOR CONTINUOUS OSB MANUFACTURING

FLEXOPLAN 163 Special embossing press belts distribute steam in the press quickly and evenly. This is made possible by a stainless steel mesh construction made of pre-twisted metal cables. The belts allow plates with a final thickness of up to 15 cm to be manufactured, as required for instance for producing OSB beams for extending walls and ceilings.

Break-proof up to 200 N/mm, suitable for temperatures up to 250°C, pressure-resistant and accurate even at great lengths – these properties also make the mesh ideal for continuous presses. The FLEXOPLAN 163 Special is available as an endless process belt with a width of up to five metres and a length of 200 metres.

FLEXOPLAN™ 163 Special (embossing press belts)

Number 18.35/4.48 p.cm

Warp 0.19/5x + E

Weft 0.30/7x

Material combination

Article no.:

SST, complete

42370304

Version with soldered seam and welded loop pin seam

Weave type plain weave

— GKD CONDUCTO® Entlüfterband / ventilation belt

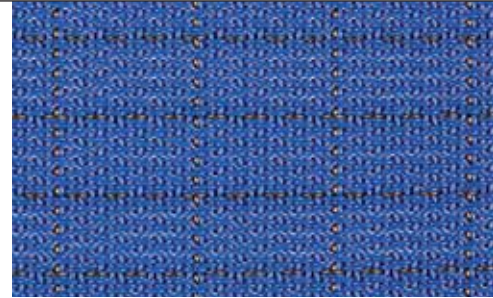
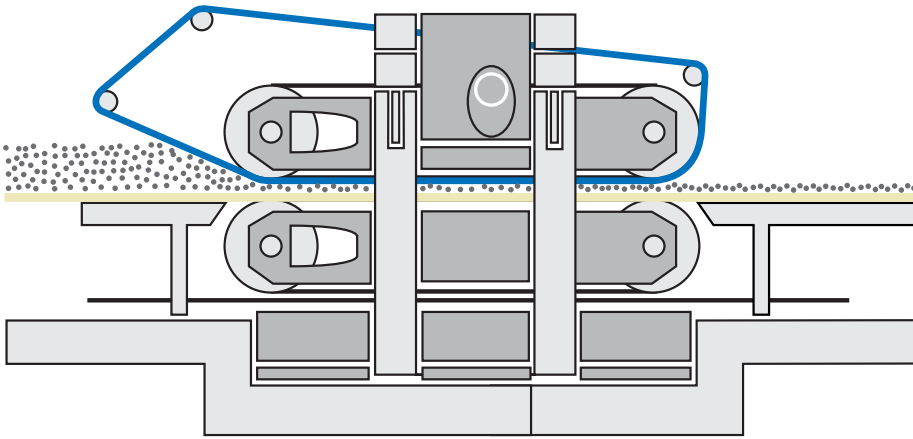

1. Diagram of prepress 2. CONDUCTO 2206 3. CONDUCTO 5090

CONDUCTO® VENTILATION BELTS FOR ATEX-COMPLIANT APPLICATIONS

CONDUCTO is a patented ventilation belt that sets new standards for safety and productivity in the prepress. The polyester and bronze wire process belt combines high flexibility, robustness, air permeability and surface smoothness with maximum conductivity. Bronze wires woven either in warp direction or in grid form permanently prevent electrostatic charging as per the ATEX standard. As such, CONDUCTO ventilation belts reduce the risk of fire and explosion when manufacturing chip boards. Furthermore they also prevent damage to the board surfaces caused by adhesion of particles. The conductive blended mesh belts are available in widths of up to 3.4 metres. They are designed specifically to match your processes with woven pin seam, woven seam, GKD PAD seam or S-seam and can be mounted quickly on site.

| CONDUCTO | Type 2206 | Type 5090 |
|--|------------|------------|
| Material warp | PES/bronze | PES/bronze |
| Material weft | PES/bronze | PES |
| Weave | 2/2 | 3/2 |
| Tensile strength N/mm | 210 | 250 |
| Opening μm | 550 | 360 |
| Air permeability $\text{l/m}^2\text{s}$ 200 Pa | 2750 | 2200 |
| cfm 127 Pa | 425 | 340 |

ATEX 95  

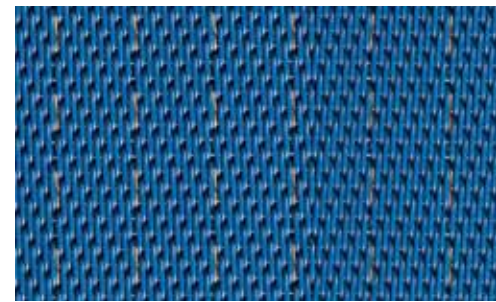

1. CONDUCTO process belts for drying wood shavings 2. PAD seam 3. CONDUCTO 5065

CONDUCTO®-PROCESS BELTS FOR PERFECTLY DRIED BIOMASS

The patented CONDUCTO 5065 is a process belt that enables optimised drying of wood shavings or other biomasses in low-temperature dryers. The high degree of air permeability and small mesh opening guarantee an effective drying process, while the special mesh construction provides reliable protection from dust. When deployed in an efficiently planned system, this helps our customers comply with the legally stipulated dust load values. The special mesh construction not only achieves excellent dust load values and air permeability, but also a

robust belt with a particularly high level of lateral stability and tensile strength. Moreover, the CONDUCTO 5065 is precise and resistant to abrasion. During production, the mesh is subjected to a special thermal treatment, allowing it to be used at working temperatures of up to 130°C. Bronze wires interwoven in the running direction permanently prevent electrostatic charging as per the ATEX standard. The belts can be cleaned easily and thoroughly using brushes or high-pressure belt washing systems. Thanks to its versatile properties, this

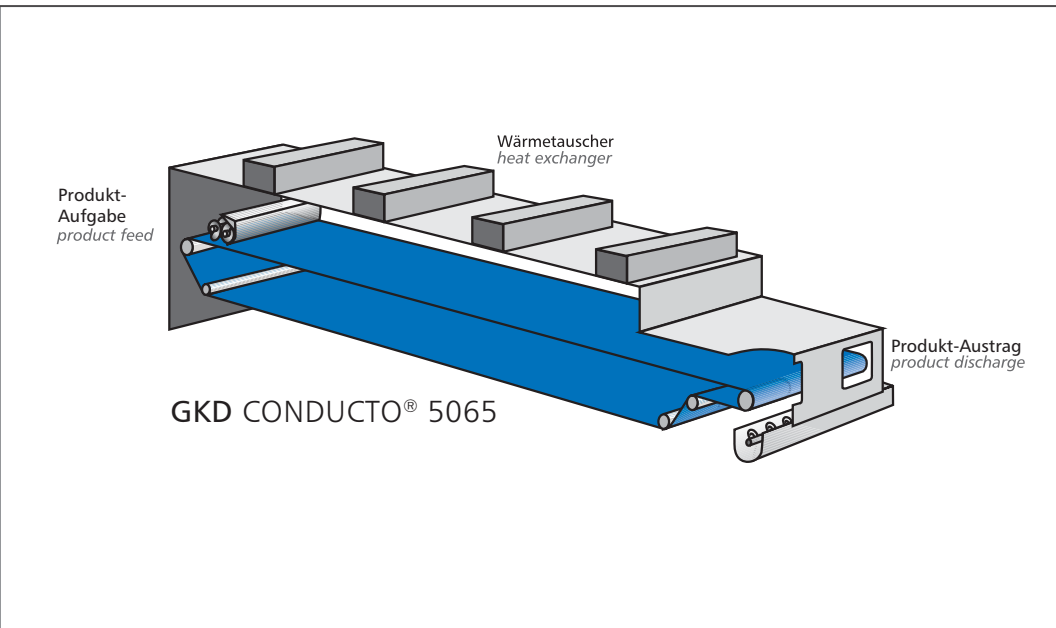

1. Diagram of belt dryer 2. Tow in device 3. Pellets

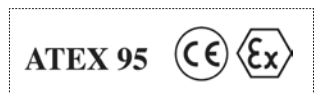

process belt has become well established on the market. Today it is used in all conventional low-temperature dryers and is exclusively fitted by numerous renowned machine manufacturers worldwide. Our robust CONDUCTO 5065 process belt is available in widths of up to 8.2 metres and lengths of up to 200 metres. To ensure the smooth installation of the belts, we can also provide you with a mounting kit for fixing the seam area and a tow in device to help feed the belt into the system on request.

| CONDUCTO | Type 5065 |
|---|------------|
| Material warp | PES/bronze |
| Material weft | PES |
| Weave | 3/2 |
| Tensile strength N/mm | 300 |
| Opening μm | 540 |
| Air permeability $\text{l/m}^2\text{s } 200 \text{ Pa}$ | 3600 |
| cfm 127 Pa | 550 |
| Tensile strength/breaking force PAD seam 20 | 150 N/mm |

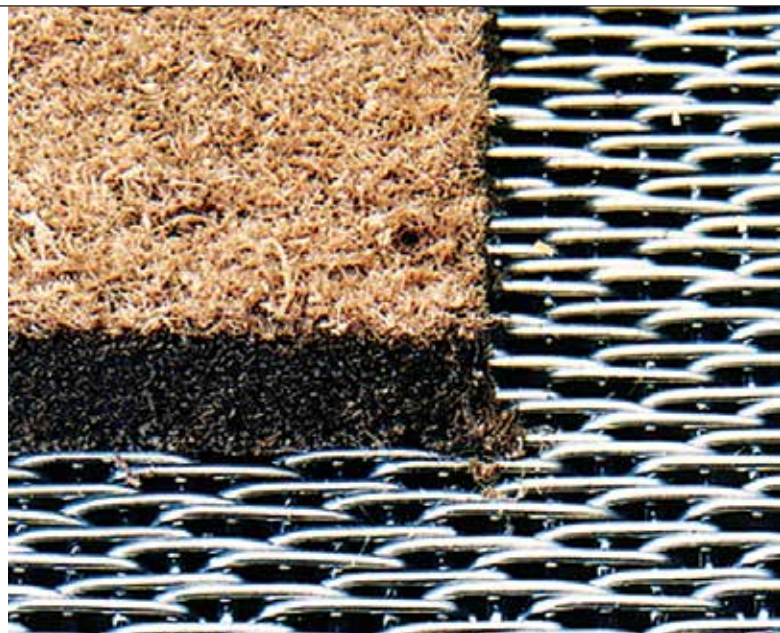
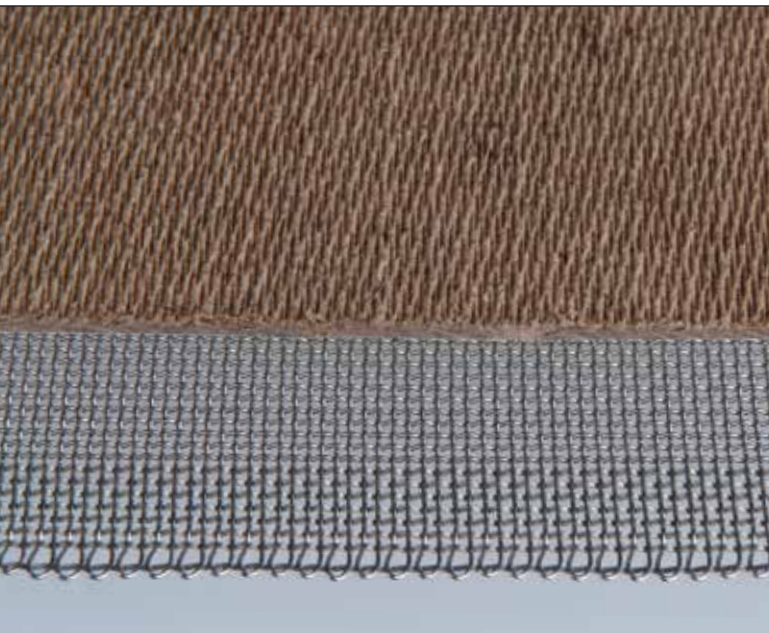

1. Press mesh with selvage 2. TELA MICRODUR

SQUARE WEAVE + TELA MICRODUR FOR FB HARD PARTICLE BOARDS

Our stainless steel SQUARE WEAVE and TELA MICRODUR meshes have been tried and tested as reliable press draining meshes for many years, and are today used in the furniture and automotive industries among other areas. These solutions allow manufacturers all over the world to produce FB hard particle boards economically and effectively using a wet process. Our SQUARE WEAVE stands out in particular thanks to its plain weave and stable woven edge. This mesh is an ideal choice for manufacturing FB hard particle boards with its characteristic surface structure. The special weave of

the TELA MICRODUR mesh is the perfect solution when the end product needs to have a particularly smooth surface. These smooth surfaces guarantee a good product discharge and are highly cost-effective in production. Both meshes stand out thanks to their outstanding dewatering performance. They are produced solely in our competence centre for press draining meshes in South Africa. Like all process meshes from GKD, they are manufactured according to the individual specifications and applications of our customers.

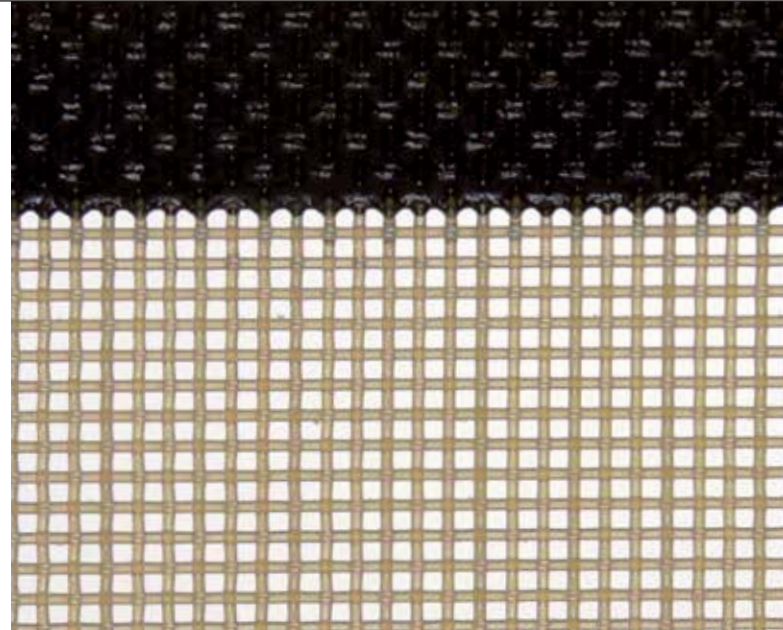
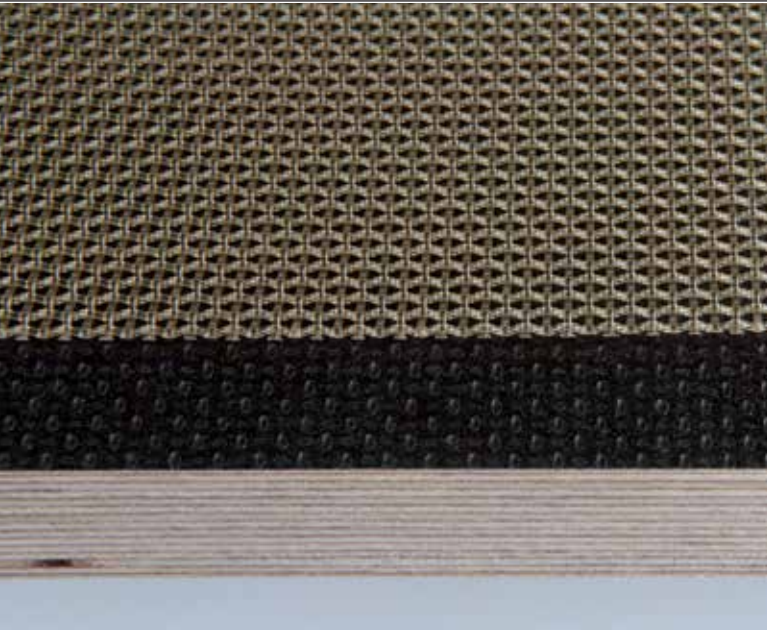

1. Multiplex board with GKD LINEAR SCREEN 1300 2. PPS with special GKD edge coating

LINEAR SCREEN FOR PRESSING VENEERS

LINEAR SCREEN 1300 and 3000 made from polyphenylene sulphide (PPS) are reliable meshes for pressing veneers when manufacturing multiplex (textured coated) boards. Among other applications, these boards are often used as non-slip flooring in industrial plants or truck and trailer manufacturing. Our mesh lends the board its distinctive structure. To realise this non-slip surface, high temperatures and pressing power are required during the production process. This is where conventional plastics and adhesives

reach their limits. For this reason, LINEAR SCREEN employs an individually extruded plastic consisting of polyphenylene sulphide and a special adhesive for edge coating in the veneer industry. After weaving, the mats also undergo a complex thermal treatment procedure in order to prevent shrinkage during the tough production processes of our customers. In this connection, the edges of all LINEAR SCREEN meshes are also finished with an innovative and highly heat-resistant edge coating.

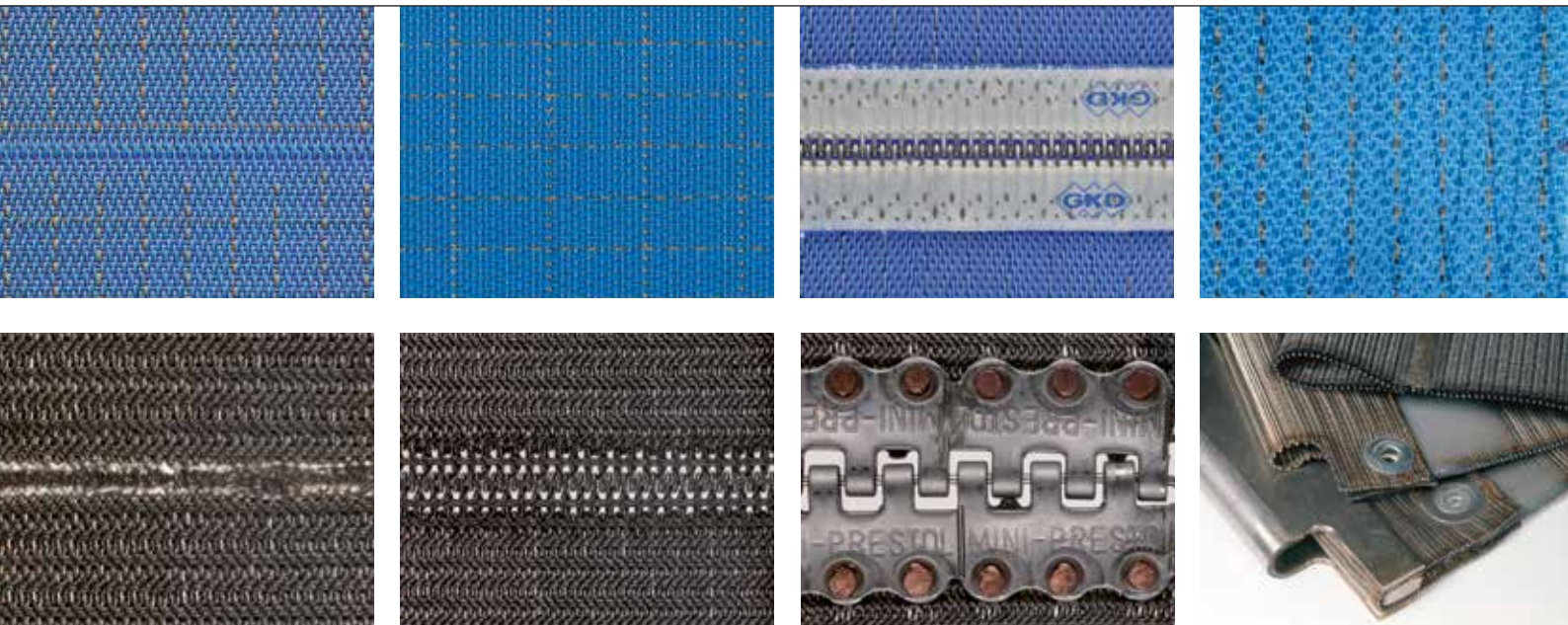

Seam variants for plastic (1-4) and metal (5-8)

INDIVIDUAL SEAM SOLUTIONS FOR EVERY APPLICATION

Like our meshes themselves, the seams also have to withstand extremely tough conditions: depending on the area of application, we combine one of our seam variants with the optimum mesh for our customers' production processes. We are happy to support and advise you in choosing the right seam for your particular requirements.

The patented and particularly flat PAD seam is exclusively available from GKD. In a hot melting procedure, a special pad is melted into the belt mesh and pressed together with staples. As a result, the special seam is stronger, more durable and possesses better running properties. Furthermore, the risk of damage to the seams is reduced to a minimum, the seam area is closed more tightly and product penetration is reduced.

| SEAMS FOR PLASTIC BELTS (pictures 1-4) | |
|--|---|
| Woven pin seam | minimal marking, air permeable, can be closed by customers |
| Woven seam | non-marking, continuous air flow |
| GKD PAD seam | particularly thin, robust and minimal-marking hook seam, patented and exclusive from GKD |
| S-seam | minimal marking, can be closed on customer's premises using a hot press |
| SEAMS FOR METAL BELTS (pictures 5-8) | |
| Soldered seam | available with prepared seam for soldering into the system by GKD fitters or as an endless belt. Both options offer minimal marking and high tensile strength |
| Welded loop pin seam | enables the belt to be closed by the customer on their own premises |
| Miniprestol seam | robust seam for Flexoplan mesh belts |
| Connection guide | customised production in accordance with drawing provided |

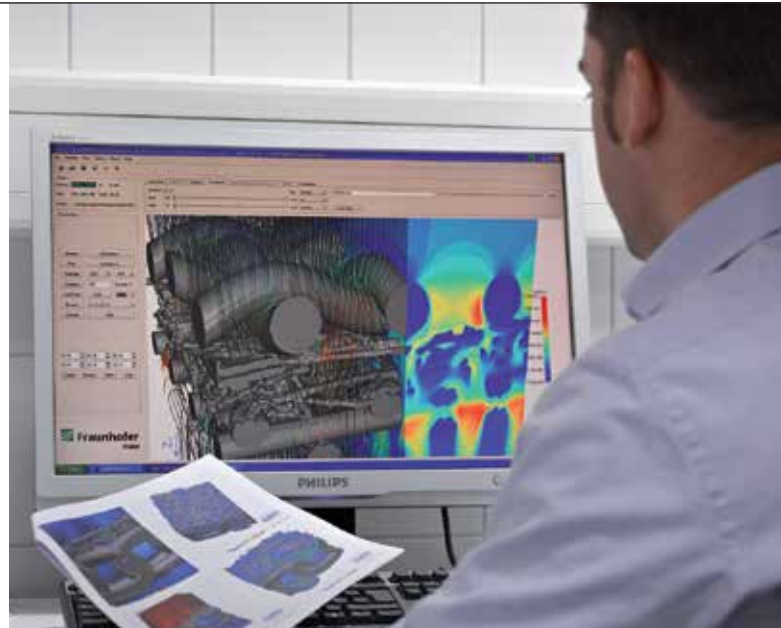

1. Mesh construction 2. Computer simulation

RESEARCH + DEVELOPMENT FOREVER BETTER PRODUCTS

Technical expertise and optimal customer benefit – this is GKD’s mission for all process meshes employed in the wood industry. That’s why we focus on the development of new meshes in addition to our existing product portfolio. Detailed analyses of current or planned applications always serve as the basis when developing innovative and efficient solutions. Our engineers and technicians combine a wealth of expertise in production, materials and systems with a wide range of practical knowledge of process technologies. Computer simulations support these processes. This all results in excellent GKD mesh quality that is perfectly matched to market requirements. For many years, we have guaranteed this high standard by continuously developing and deploying the very latest manufacturing processes – just like our products themselves.

BENEFITS FOR OUR CUSTOMERS

- VIRTUAL MESH DEVELOPMENT AND PROCESS OPTIMISATION
 - COMPUTER SIMULATIONS FOR PREDICTING PERMEABILITY AS WELL AS PARTICLE AND DIRT PENETRATION
 - EXTENDED SERVICE LIFE THANKS TO OPTIMISED MANUFACTURING AND PROCESS PARAMETERS
-

GKD – GEBR. KUFFERATH AG

Metallweberstraße 46
52353 Düren
Germany
T +49 (0) 2421 803 - 0
F +49 (0) 2421 803 - 182
weaveinmotion@gkd.de
www.gkd.de

GKD – GEBR. KUFFERATH AG

As a privately owned technical weaving mill, we are the world market leader in woven solutions made of metal and plastic. Under the slogan GKD – WORLD WIDE WEAVE, our company groups four independent business divisions: SOLIDWEAVE (industrial mesh), WEAVE IN MOTION (process belt mesh), CREATIVEWEAVE (architectural mesh) and COMPACTFILTRATION (compact filtration systems). GKD continuously develops new fields of applications with manufacturing technology and process expertise. We use GKD meshes to create efficient systems, equipment and components integrated perfectly in the customer's process across all industry sectors. With seven plants in Germany (headquarters), USA, United Kingdom, South Africa, China, India and Chile, GKD is close to the markets all over the world. More subsidiaries and worldwide representatives are also available to our customers in France, Spain, Dubai, Qatar and elsewhere.

BUSINESS UNIT: WEAVE IN MOTION

As a technological leader, GKD offers a range of versatile, woven process belts for demanding applications under the WEAVE IN MOTION brand. Customers all over the world use our range of products and custom-built solutions to drain, press, filter, separate, dry, cool or freeze products. In addition, the process belts are deployed in applications including the embossing of wood, heat treatment and applications in the textile and non-woven industries. Thanks to production on-state-of-the-art heavy-duty weaving machines, our meshes made of plastic, metal or a combination of materials are highly stable and at the same time flexible. More-over, the ultra-flat PAD seam developed by GKD engineers demonstrates our innovative capacity. We are a reliable partner for all projects right from the beginning: from consulting and individual development, right up to procurement and assembly.

GKD – PRODUCTS AND SERVICE CLOSE TO OUR CUSTOMERS, WORLDWIDE.

- 01 GKD GERMANY, Düren (Headquarter)
- 02 GKD UK, North Yorkshire
- 03 GKD FRANCE, Croisilles
- 04 GKD SPAIN, Barcelona
- 05 GKD USA, Cambridge, MD
- 06 GKD LATIN AMERICA, Santiago de Chile
- 07 GKD SOUTH AFRICA, Randfontein
- 08 GKD INDIA, Jaipur
- 09 GKD CHINA, Beijing
- 10 GKD MIDDLE EAST, Dubai
- 11 GKD MIDDLE EAST, Doha

